

Deck Selection Guide

Doc. # 99-5127

Standard Deck

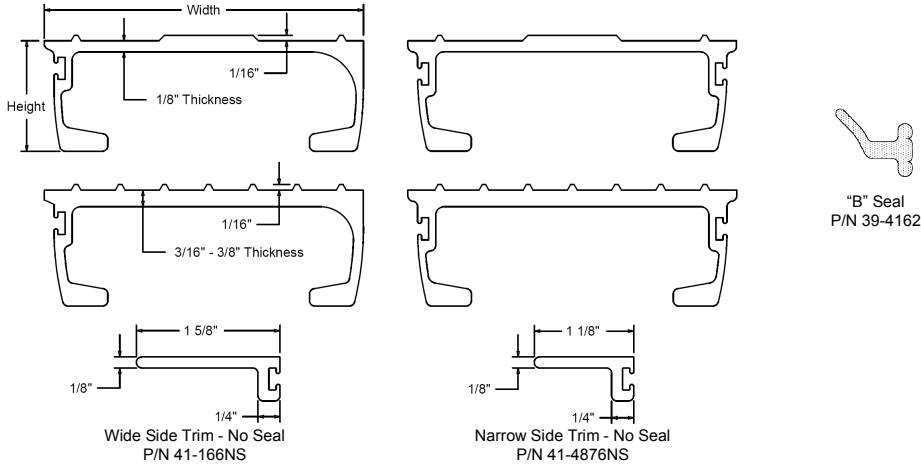

Deck Type	Thickness (in.)	Width (in.)	Height (in.)	Part No.	Deck Type	Thickness (in.)	Width (in.)	Height (in.)	Part No.
35-2	1/8	3-5/8	1-1/4	41-268	35-2 Double Seal	1/8	3-23/32	1-1/4	41-3046
35-3	3/16	3-5/8	1-5/16	41-275	35-3 Double Seal	3/16	3-23/32	1-5/16	41-2791
35-4	1/4	3-5/8	1-3/8	41-270	35-4 Double Seal	1/4	3-23/32	1-3/8	41-2771
35-6	3/8	3-5/8	1-1/2	41-104	35-6 Double Seal	3/8	3-23/32	1-1/2	41-2769
37-2	1/8	3-7/8	1-1/4	41-271	37-2 Double Seal	1/8	3-31/32	1-1/4	41-3047
37-3	3/16	3-7/8	1-5/16	41-272	37-3 Double Seal	3/16	3-31/32	1-5/16	41-2780
37-4	1/4	3-7/8	1-3/8	41-273	37-4 Double Seal	1/4	3-31/32	1-3/8	41-289
37-6	3/8	3-7/8	1-1/2	41-283	37-6 Double Seal	3/8	3-31/32	1-1/2	41-288
40-3.5	7/32	3-31/32	1-11/32	41-2951	40-3.5 Double Seal	7/32	4-1/16	1-11/32	41-2952
40-5.5	11/32	3-31/32	1-15/32	41-3009	40-5.5 Double Seal	11/32	4-1/16	1-15/32	41-3010

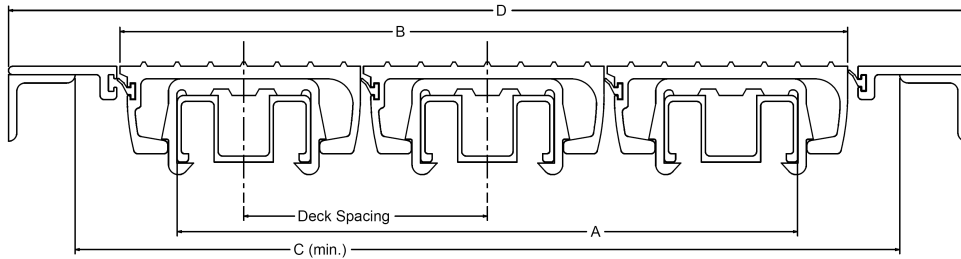

Deck Slat Type	Deck Spacing (in., O.C.)	No. of Slats	Dim. A (in.)	Dim. B (in.)	Dim. C (in.)	Dim. D* (in.)
35	3-21/32	18	64-5/32	65-9/16	66-9/16	69-13/32
37	3-29/32	18	68-13/32	70-5/16	71-11/16	73-29/32
40	4	18	70	72	72-3/4	75-19/32
35	3-21/32	21	75-1/8	76-25/32	77-17/32	80-3/8
37	3-29/32	21	80-1/8	82-1/32	82-25/32	85-5/8
40	4	21	82	84	84-3/4	87-19/32
35	3-21/32	24	86-3/32	87-3/4	88-1/2	91-11/32
37	3-29/32	24	91-27/32	93-3/4	94-1/2	97-11/32
40	4	24	94	96	96-3/4	99-19/32

*With 1-5/8" wide side trim, 41-166NS

Double Ridge™ & Triple Ridge™ Deck

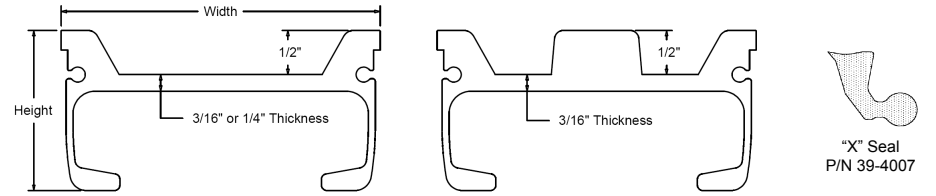

Deck Type	Thickness (in.)	Width (in.)	Height (in.)	Part No.
35-3 Double Ridge	3/16	3-5/8	1-13/16	41-3462
35-4 Double Ridge	1/4	3-5/8	1-7/8	41-3958
37-3 Double Ridge	3/16	3-7/8	1-13/16	41-3482
37-4 Double Ridge	1/4	3-7/8	1-7/8	41-3979
40-3 Double Ridge	3/16	3-15/16	1-13/16	41-3486
40-4 Double Ridge	1/4	3-15/16	1-7/8	41-3795
35-3 Triple Ridge	3/16	3-5/8	1-13/16	41-4164
37-3 Triple Ridge	3/16	3-7/8	1-13/16	41-4167
40-3 Triple Ridge	3/16	3-15/16	1-13/16	41-4184

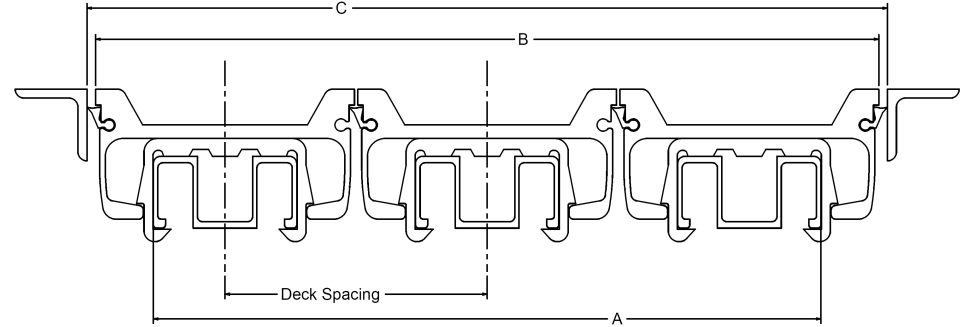

Deck Slat Type	Deck Spacing (in., O.C.)	No. of Slats	Dim. A (in.)	Dim. B (in.)	Dim. C (in.)
35	3-21/32	18	64-5/32	65-25/32	66-1/32
37	3-29/32	18	68-13/32	70-9/32	70-17/32
40	4	18	70	71-31/32	72-7/32
35	3-21/32	21	75-1/8	76-3/4	77
37	3-29/32	21	80-1/8	82	82-1/4
40	4	21	82	83-31/32	84-7/32
35	3-21/32	24	86-3/32	87-23/32	87-31/32
37	3-29/32	24	91-27/32	93-23/32	93-31/32
40	4	24	94	95-31/32	96-7/32

Subdeck & Wearplate

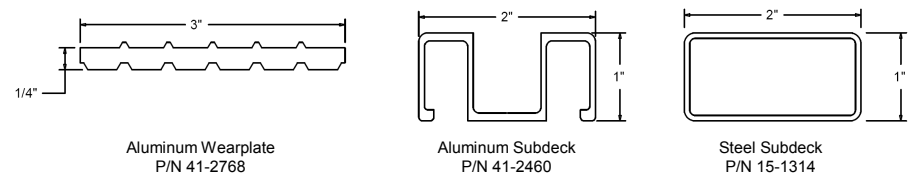

Top Seal™ & Tufdeck™

Top Seal

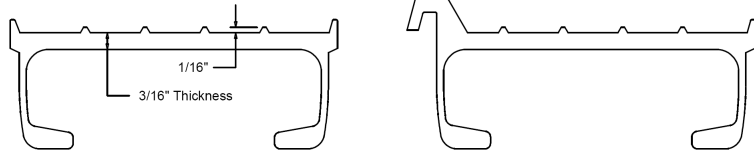
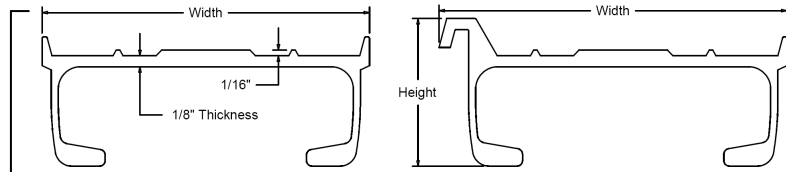

Tufdeck

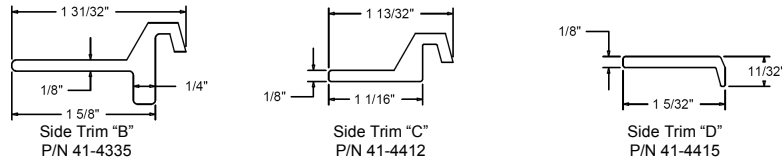
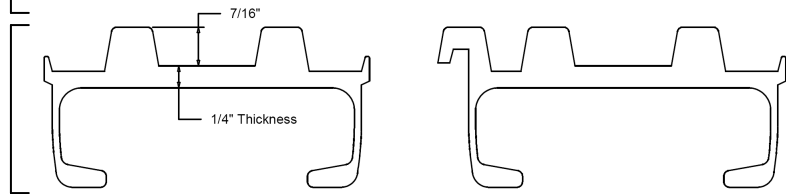

Deck Type	Thickness (in.)	Width (in.)	Height (in.)	Part No.	Deck Type	Thickness (in.)	Width (in.)	Part No.
35-2 Top Seal	1/8	3-15/16	1-21/32	41-4337	35-2 Top Seal - Side	1/8	3-23/32	41-4436
35-3 Top Seal	3/16	3-15/16	1-23/32	41-4693	35-3 Top Seal - Side	3/16	3-23/32	41-4694
37-2 Top Seal	1/8	4-7/32	1-21/32	41-4414	37-2 Top Seal - Side	1/8	3-31/32	41-4437
37-3 Top Seal	3/16	4-7/32	1-23/32	41-4684	37-3 Top Seal - Side	3/16	3-31/32	41-4685
35-4 Tufdeck	1/4	3-15/16	1-13/16	41-4434	35-4 Tufdeck - Side	1/4	3-11/16	41-4435
37-4 Tufdeck	1/4	4-7/32	1-13/16	41-4420	37-4 Tufdeck - Side	1/4	3-31/32	41-4422

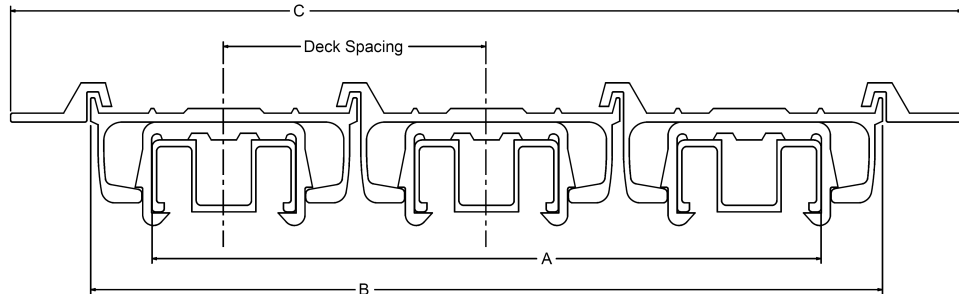

Deck Slat Type	Deck Spacing (in., O.C.)	No. of Slats	Dim. A (in.)	Dim. B (in.)	Dim. C* (in.)
35	3-21/32	18	64-5/32	65-7/8	68-3/32
37	3-29/32	18	68-13/32	70-3/8	72-19/32
35	3-21/32	21	75-1/8	76-27/32	79-1/16
37	3-29/32	21	80-1/8	82-3/32	84-5/16
35	3-21/32	24	86-3/32	87-13/16	90-1/32
37	3-29/32	24	91-27/32	93-13/16	96-1/32

*With side trim "C", 41-4412

Narrow Leak Resistant Deck

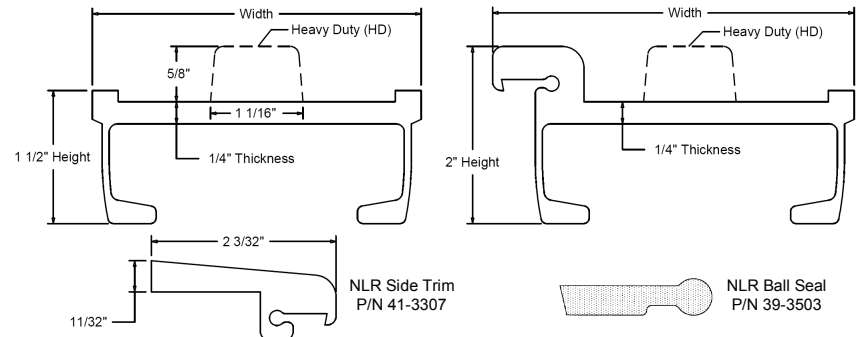

Deck Type	Thickness (in.)	Width (in.)	Height (in.)	Part No.	Deck Type	Thickness (in.)	Width (in.)	Height (in.)	Part No.
35-4	1/4	4-3/32	2	41-3281	35-4 Side	1/4	3-23/32	1-1/2	41-3282
35-4 HD	1/4	4-3/32	2	41-5025	35-4 HD Side	1/4	3-23/32	1-1/2	41-5026
37-4	1/4	4-11/32	2	41-3296	37-4 Side	1/4	3-31/32	1-1/2	41-3297
37-4 HD	1/4	4-11/32	2	41-5077	37-4 HD Side	1/4	3-31/32	1-1/2	41-5078
40-4	1/4	4-7/16	2	41-3305	40-4 Side	1/4	4-1/16	1-1/2	41-3306
40-4 HD	1/4	4-7/16	2	41-5205	40-4 HD Side	1/4	4-1/16	1-1/2	41-5206

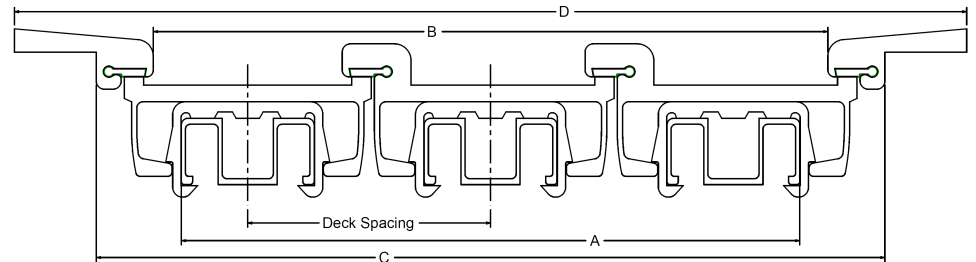

Deck Slat Type	Deck Spacing (in., O.C.)	No. of Slats	Dim. A (in.)	Dim. B (in.)	Dim. C (in.)	Dim. D (in.)
35	3-21/32	18	64-5/32	65	66-31/32	69-3/16
37	3-29/32	18	68-13/32	69.5	71-15/32	73-11/16
40	4	18	70	71-3/16	73-5/32	75-3/8
35	3-21/32	21	75-1/8	75-31/32	77-15/16	80-5/32
37	3-29/32	21	80-1/8	81-7/32	83-3/16	85-13/32
40	4	21	82	83-3/16	85-5/32	87-3/8
35	3-21/32	24	86-3/32	86-15/16	88-29/32	91-1/8
37	3-29/32	24	91-27/32	92-15/16	94-29/32	97-1/8
40	4	24	94	95-3/16	97-5/32	99-3/8

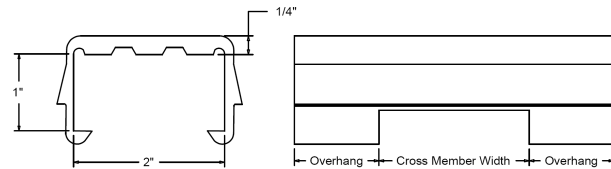

Bearings

	Cross Member Width (in.)	Overhang (in.)	Part No.
2" Special Short Bearing (HDPE)	2	7/8	39-4154
2-1/4" Bearing for Hydraulic Tube (HDPE)	2-1/4	1-1/8	39-3714
2" Bearing (HDPE)	2	1-1/8	39-2486
2-1/4" Bearing (HDPE)	2-1/4	1-1/8	39-2487
2-1/2" Bearing (HDPE)	2-1/2	1-1/8	39-2488
2-3/4" Bearing (HDPE)	2-3/4	1-1/8	39-2489
3" Bearing (HDPE)	3	1-1/8	39-2490

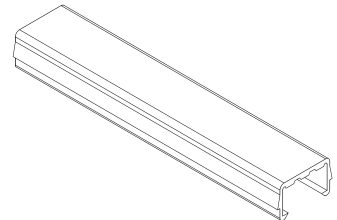

Continuous Bearing - 9 Ft Lengths
P/N 39-4093